

GORILLA SPORTS

Power Tower (10000526)

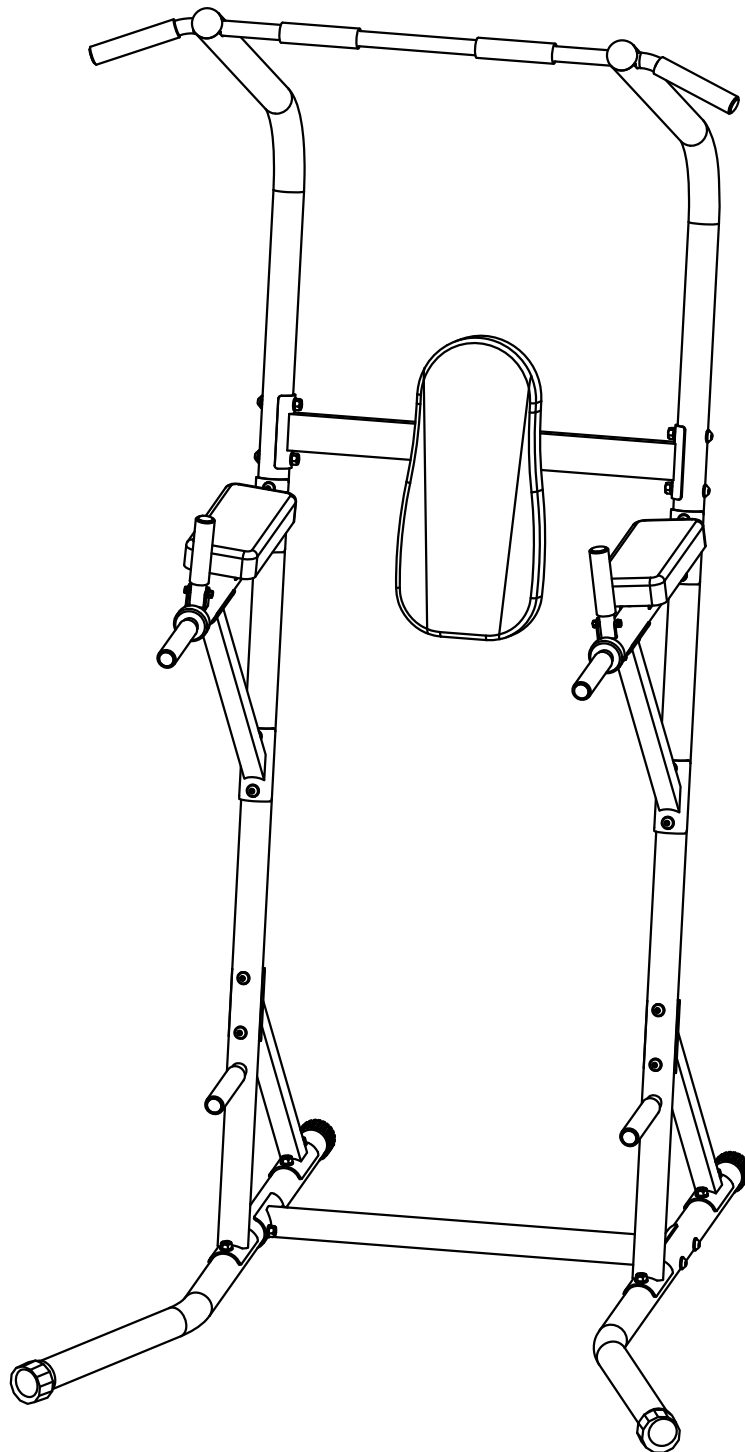



GORILLA SPORTS

Arc Washer: ($\phi 10$)

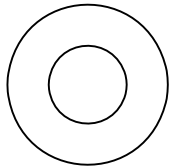

52x

Hex Nut: (M10)

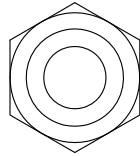

28x

Washer: ($\phi 8$)

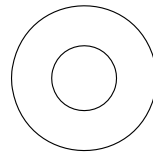

3x

Arc Washer: ($\phi 8$)

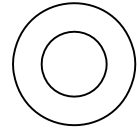

6x

Inner hex bolt (M10*67)

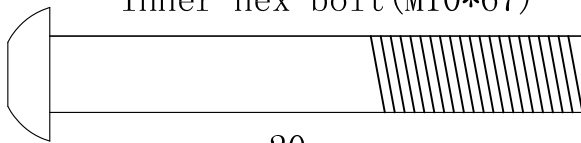

20x

Carriage bolt (M10*60)

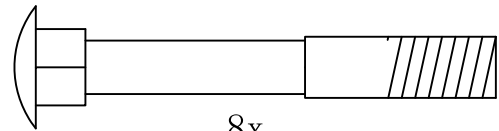

8x

Inner hex bolt (M8*65)

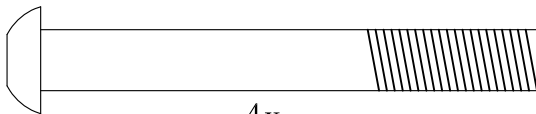

4x

Inner hex bolt (M8*45)

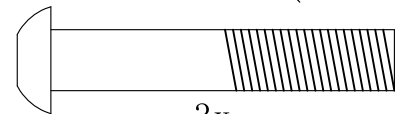

3x

Inner hexagon spanner S6

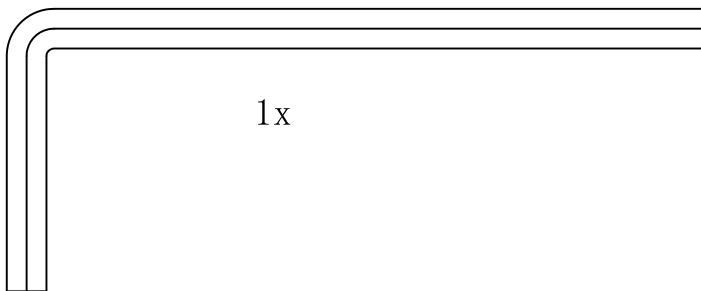

1x

Inner hex bolt (M8*35)

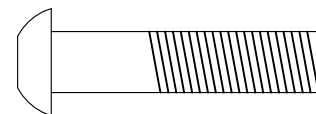

2x

Spanner

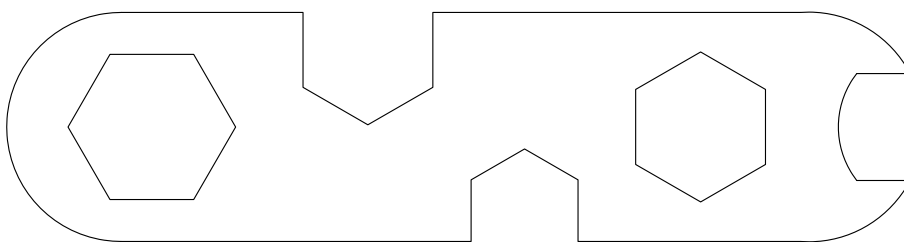

1x

Hex Bolt: (M10*20)

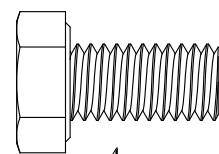

4x

1

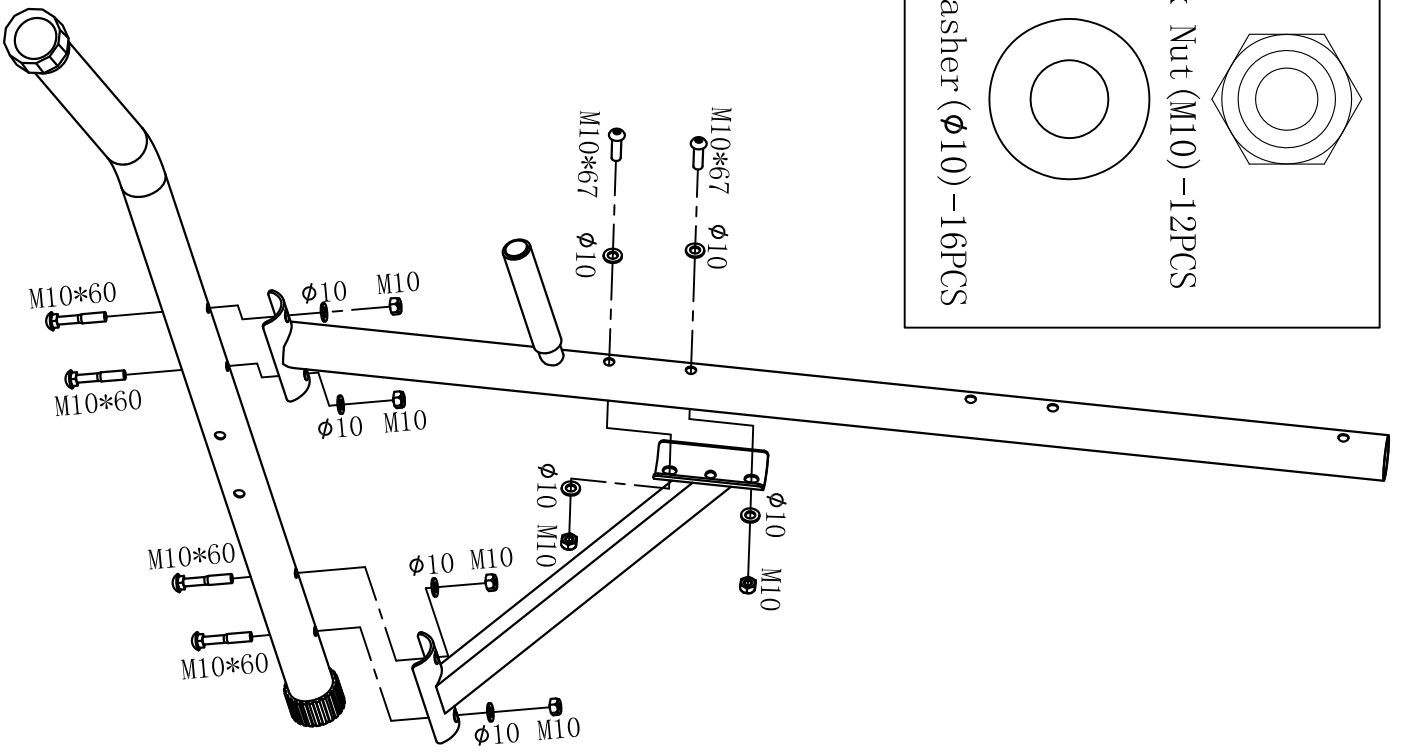
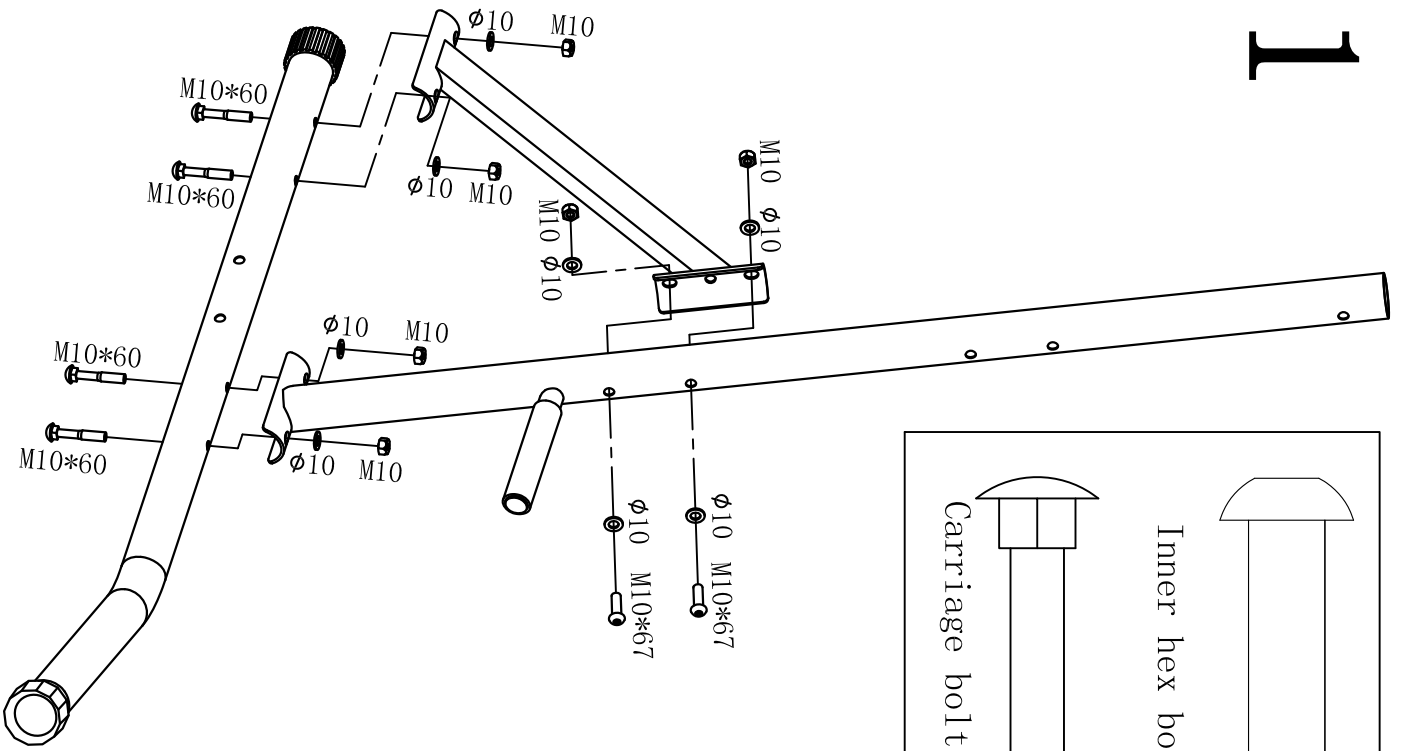

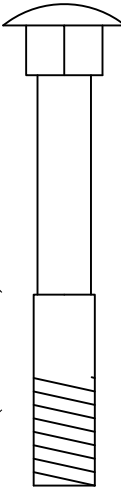
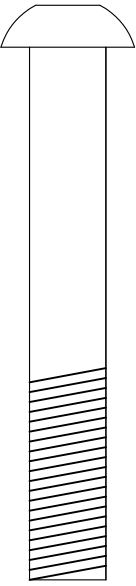
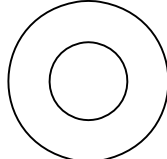
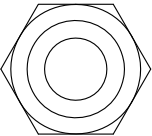
	
Carriage bolt (M10*60)-8PCS	Inner hex bolt (M10*67)-4PCS
	
Arc Washer ($\phi 10$)-16PCS	Hex Nut (M10)-12PCS

2

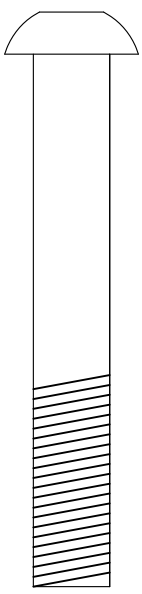
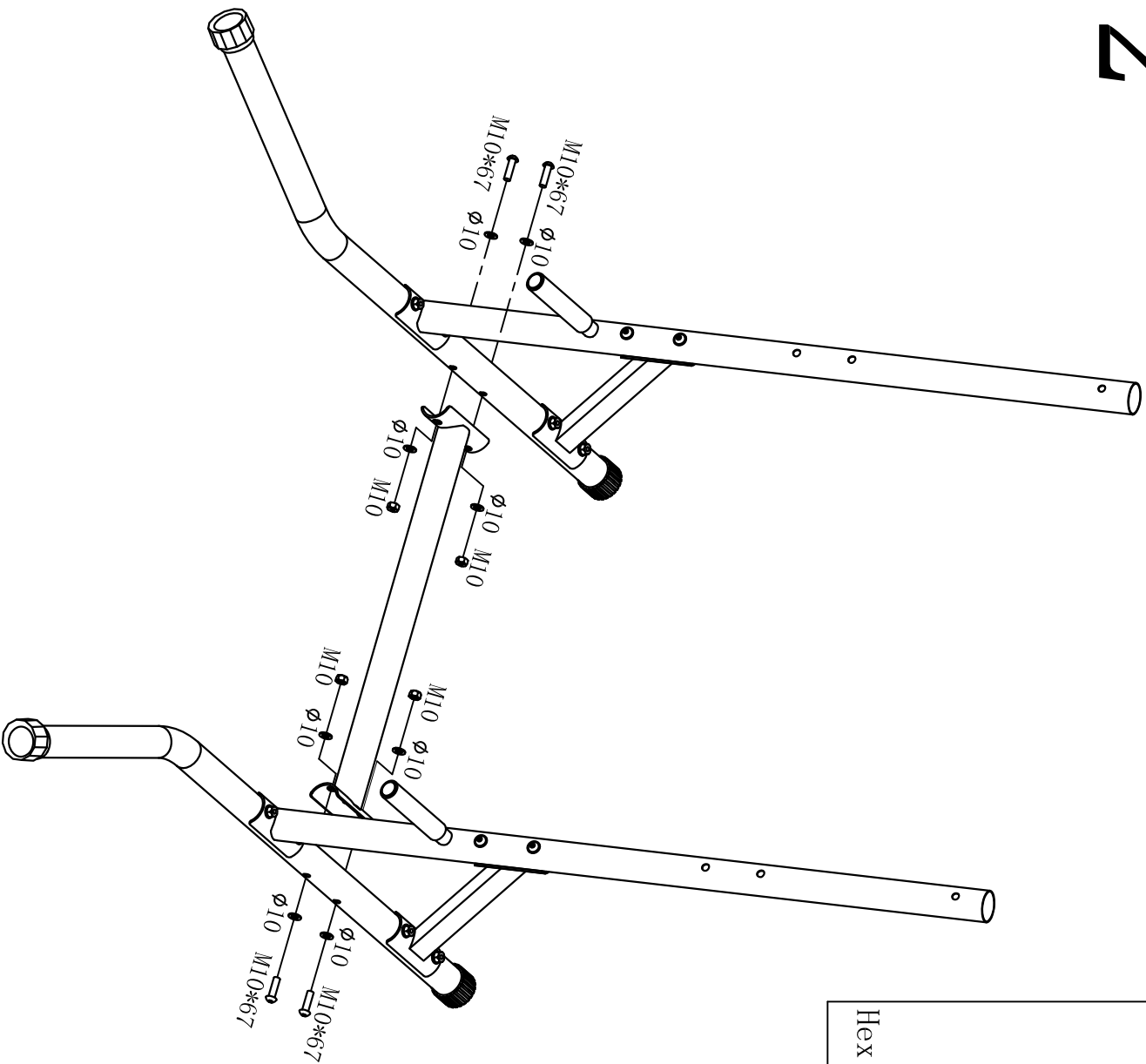

Inner hex bolt (M10*67) -4PCS

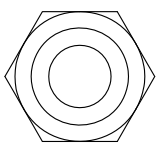

Hex Nut (M10) -4PCS

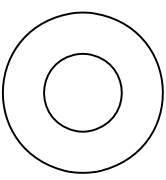

Arc Washer ($\phi 10$) -8PCS

3

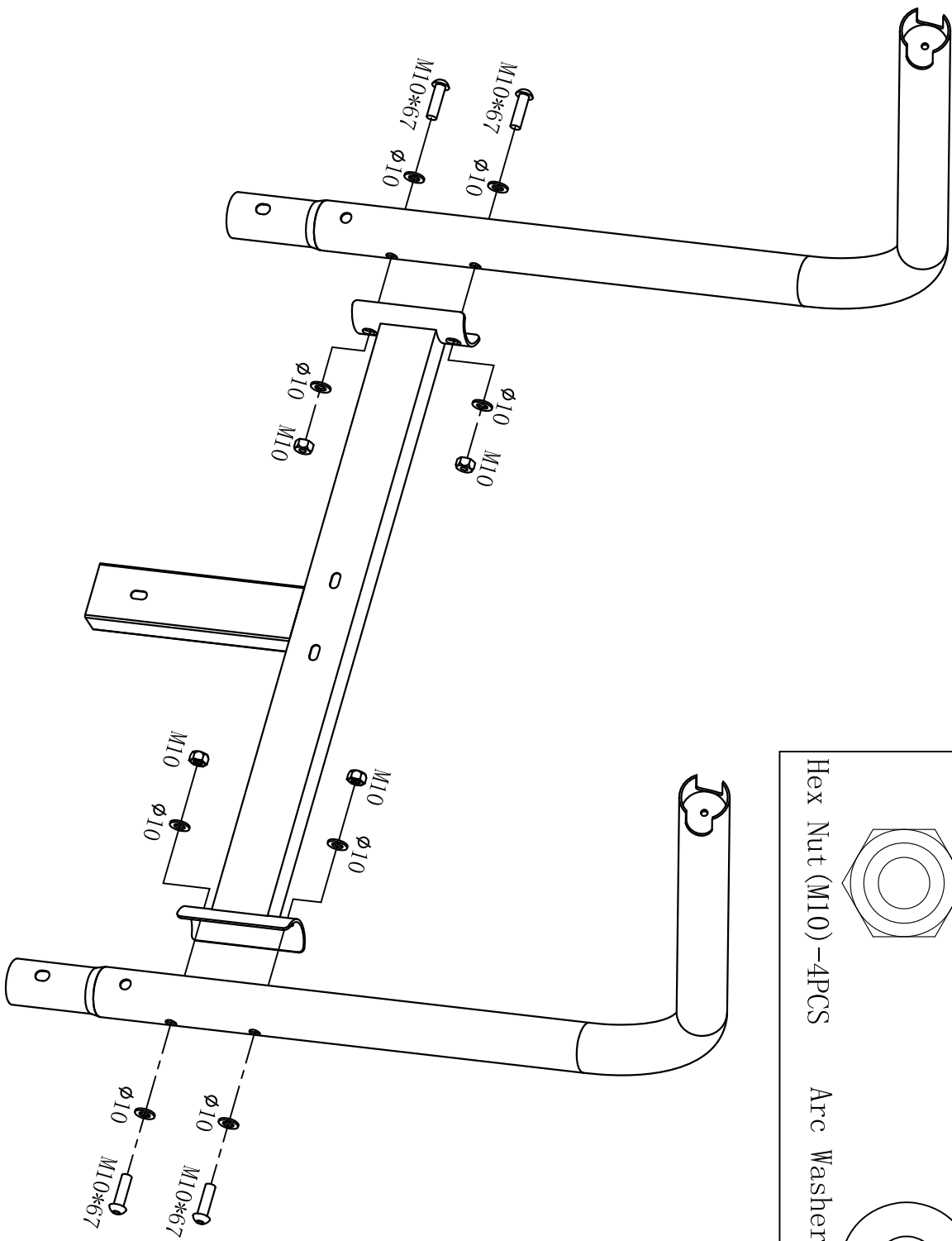

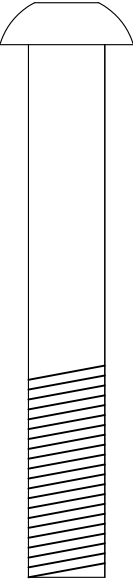
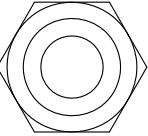
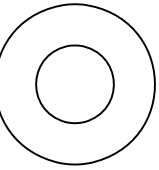
	Inner hex bolt (M10*67) -4PCS
	Hex Nut (M10) -4PCS
	Arc Washer (φ10) -8PCS

4

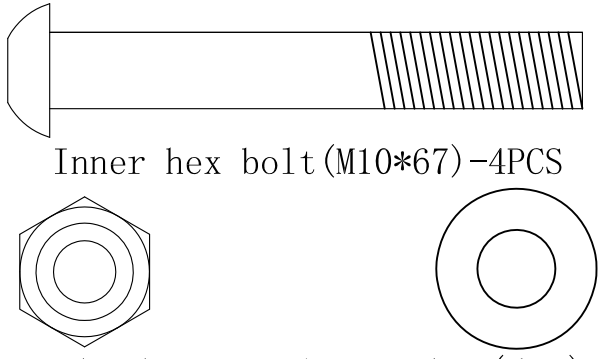

Inner hex bolt (M10*67) - 4PCS

Hex Nut (M10) - 4PCS Arc Washer ($\phi 10$) - 8PCS

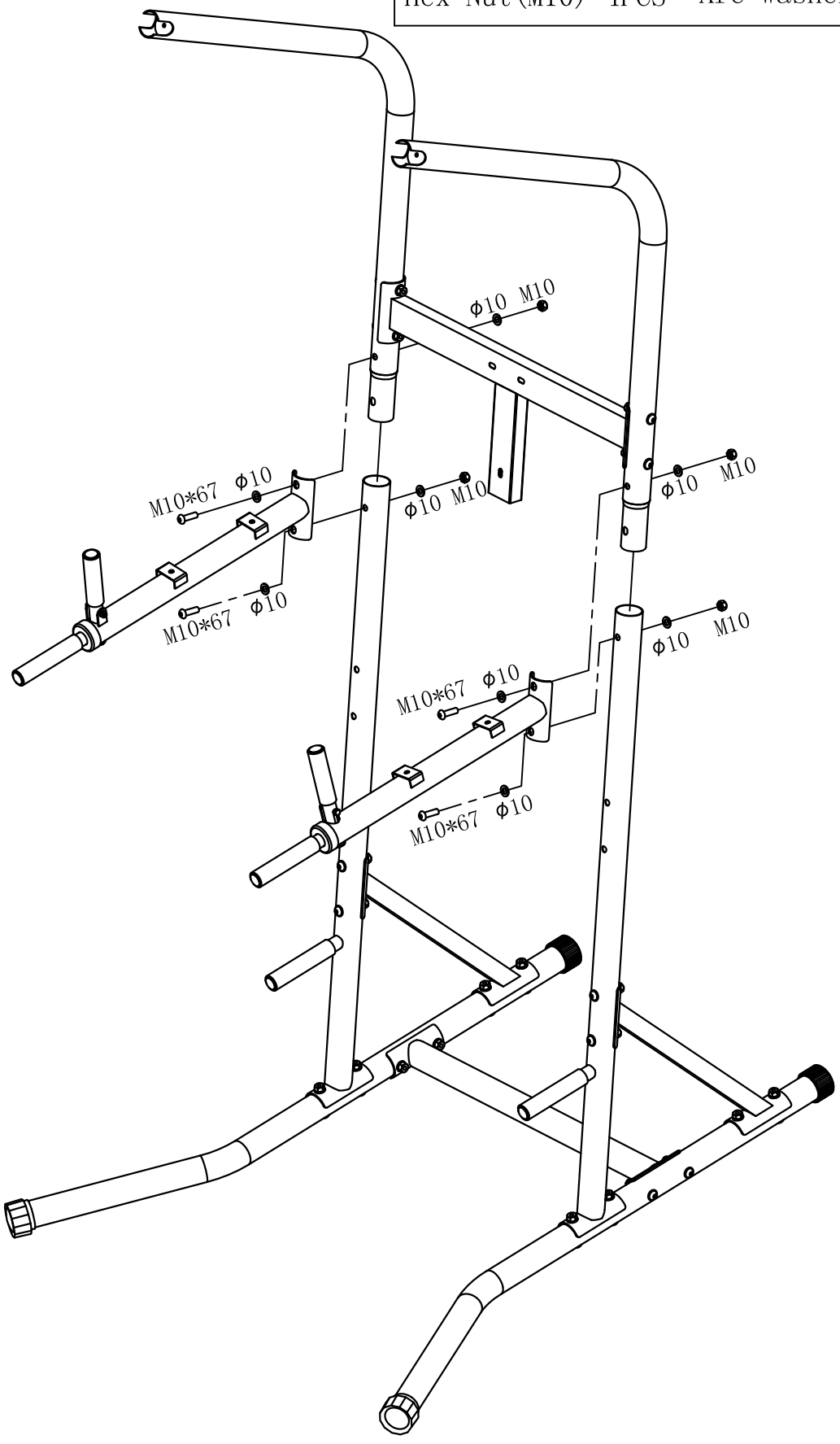

5

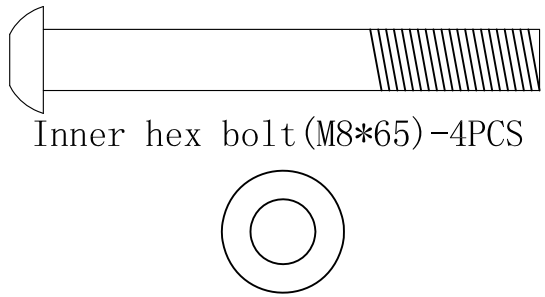

Inner hex bolt (M8*65) -4PCS

Arc Washer (Ø8) -4PCS

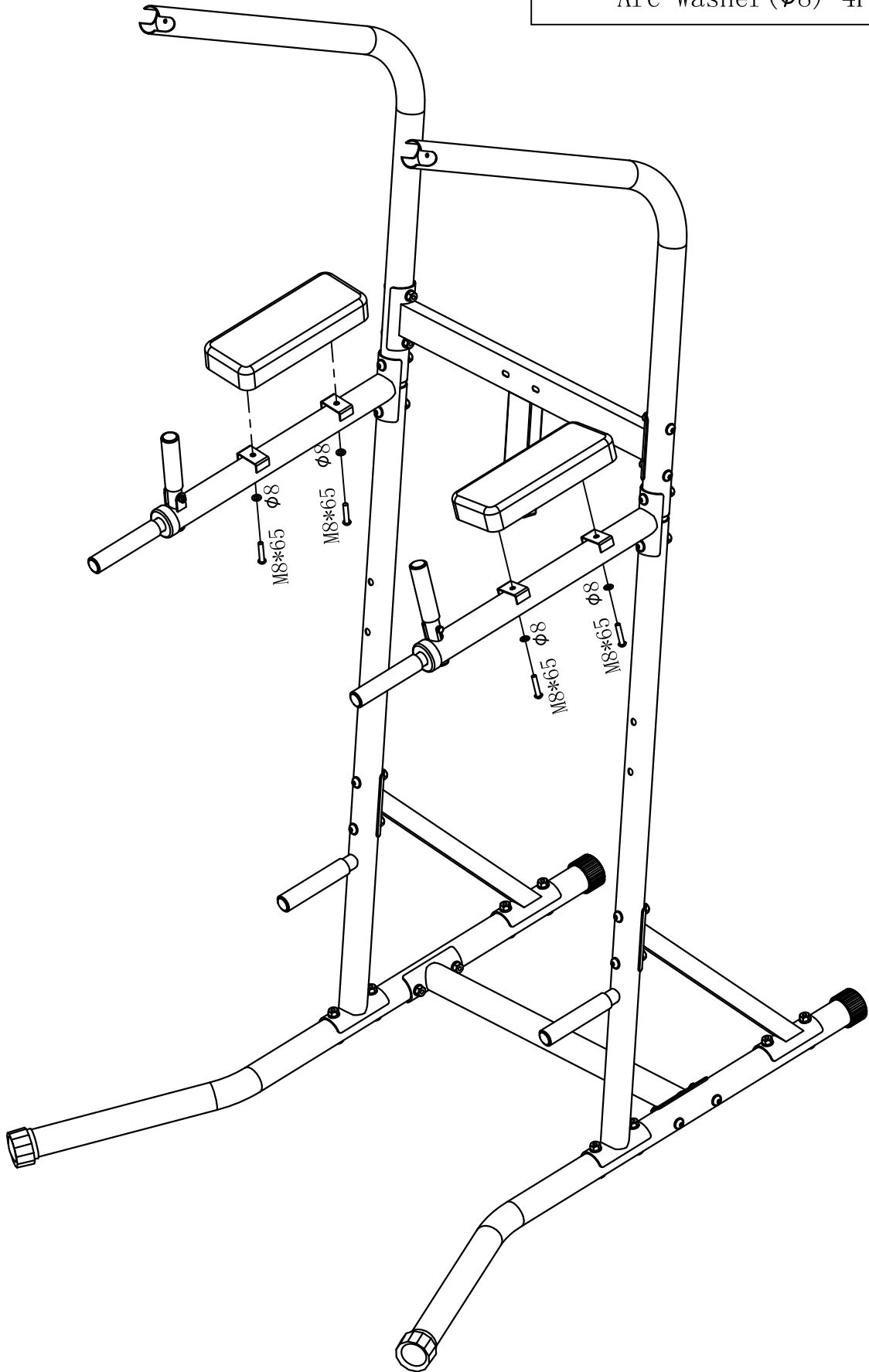

6

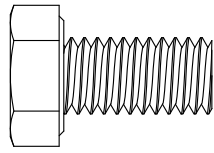

Hex Bolt (M10*20) -4PCS

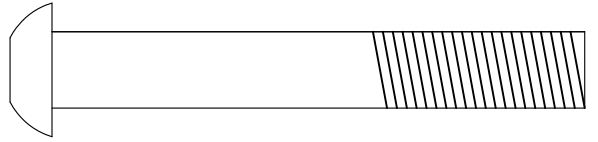

Inner hex bolt (M10*67) -4PCS

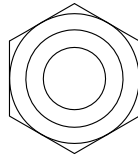

Hex Nut (M10) -4PCS

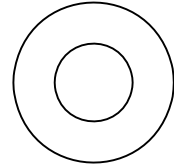

Arc Washer (φ10) -12PCS

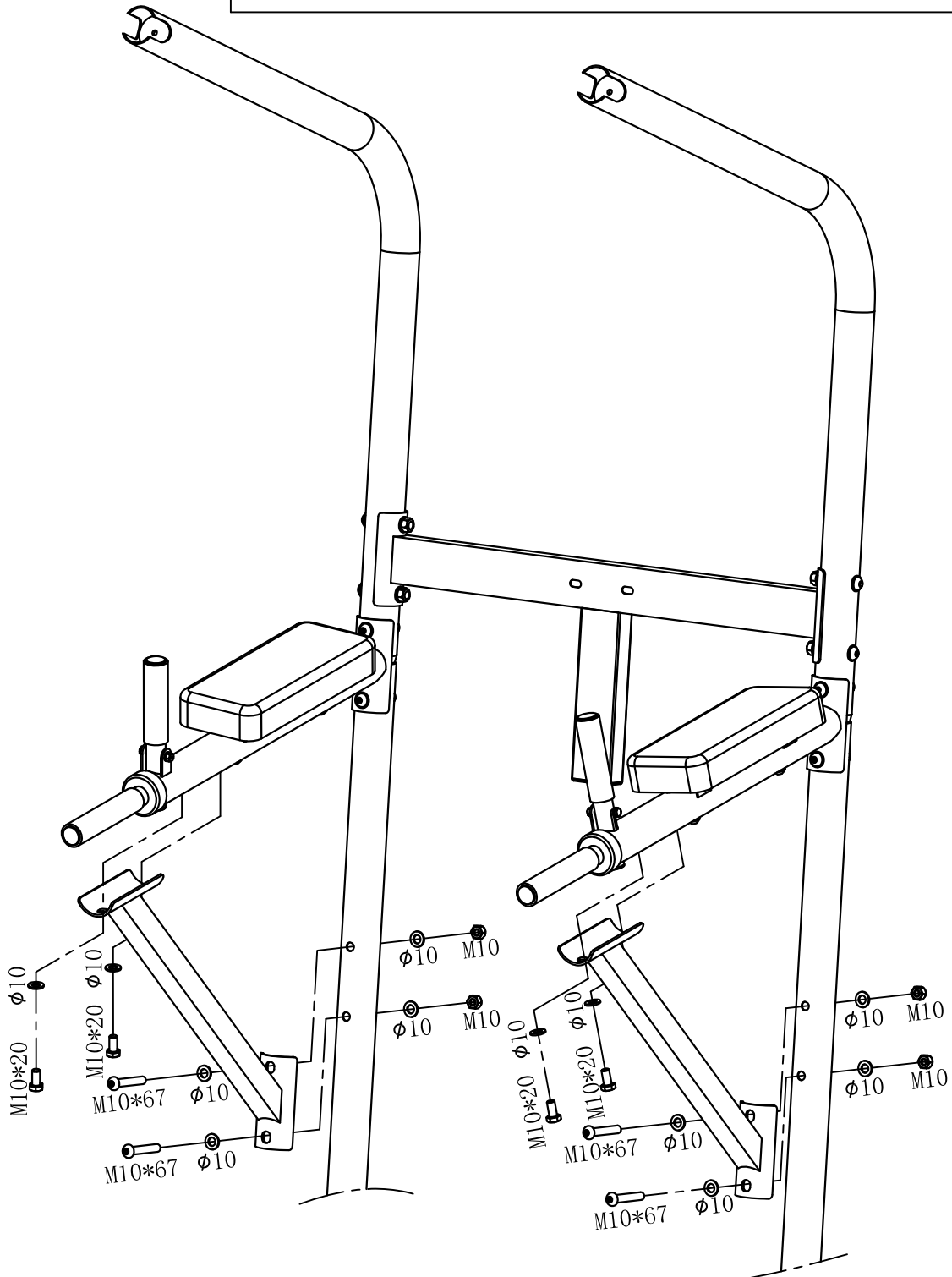

7

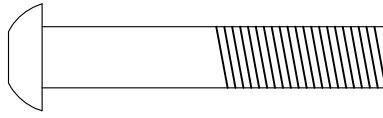

Inner hex bolt (M8*45) - 3PCS

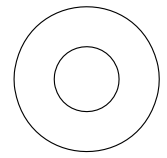

Washer (ø8) - 3PCS

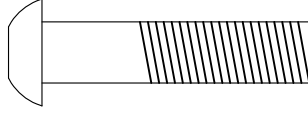

Inner hex bolt (M8*35) - 2PCS

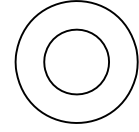

Arc Washer (ø8) - 2PCS

